



BIONICLE®

71300









1x



1x

1

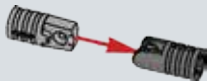

4



2

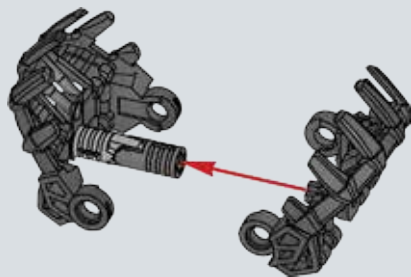



1x



1x

3

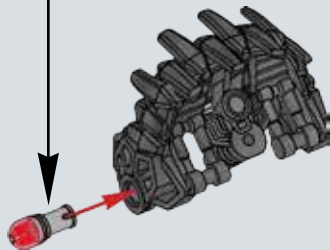
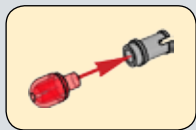

6

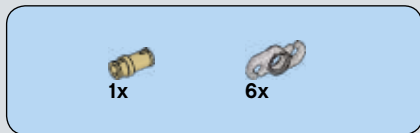

4

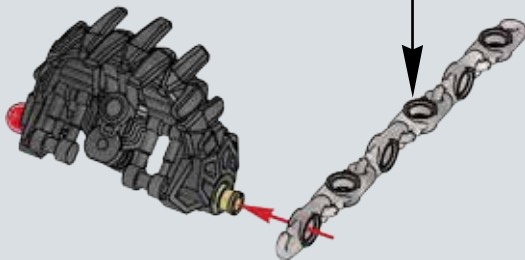
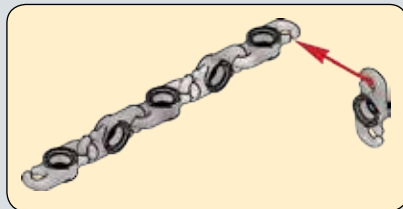
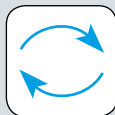



4x



4x

5

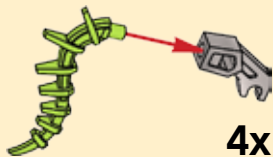

4x

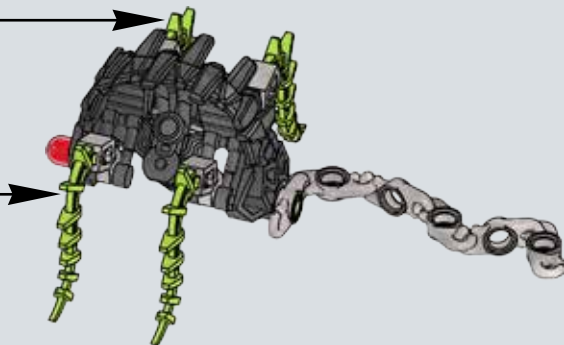

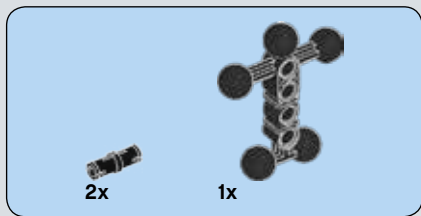

1

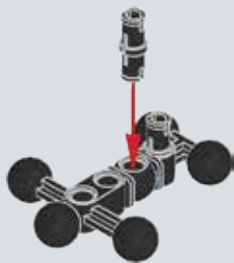



1x

2

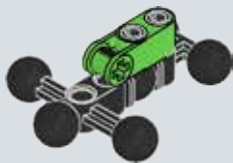

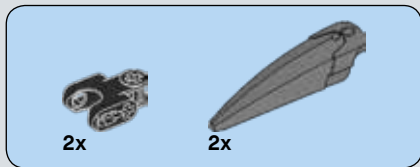

3

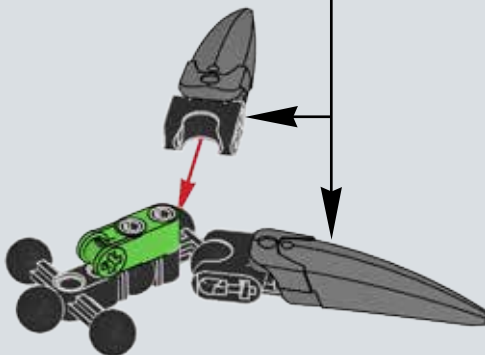
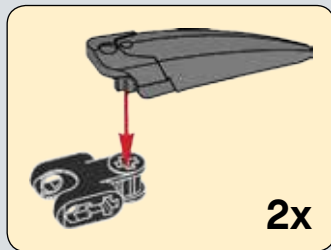

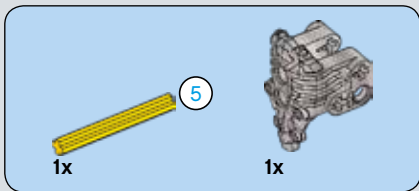

4

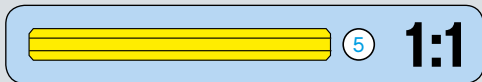
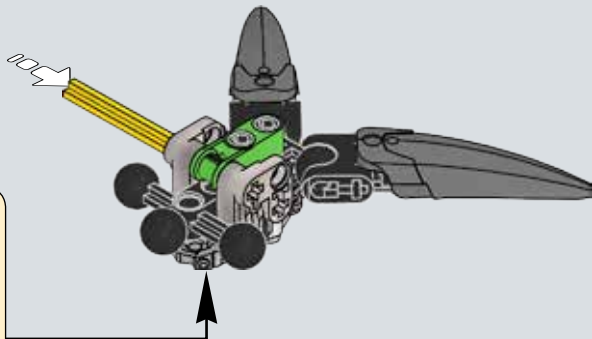
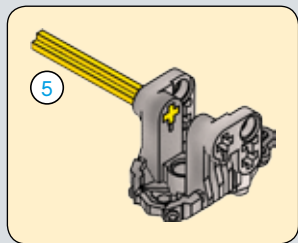



5

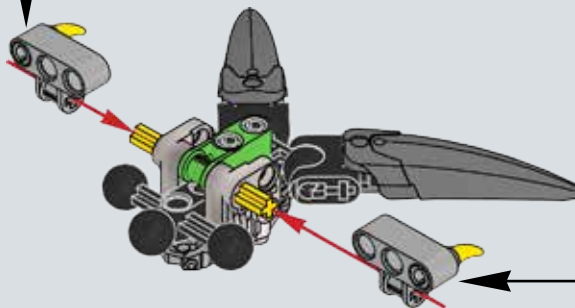
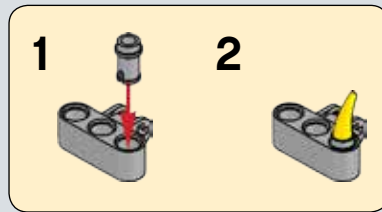
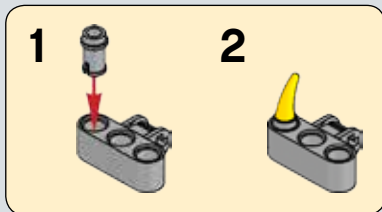



6

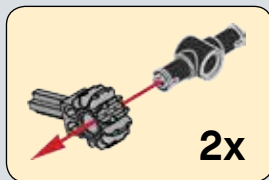

1

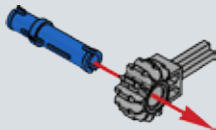

2

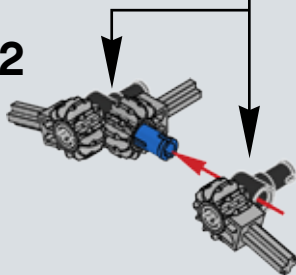

3

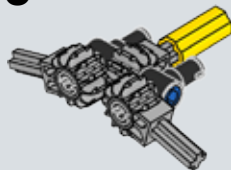

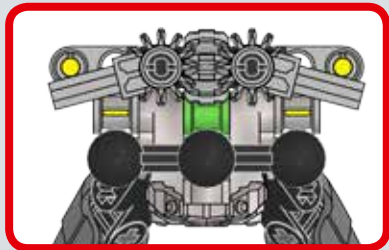
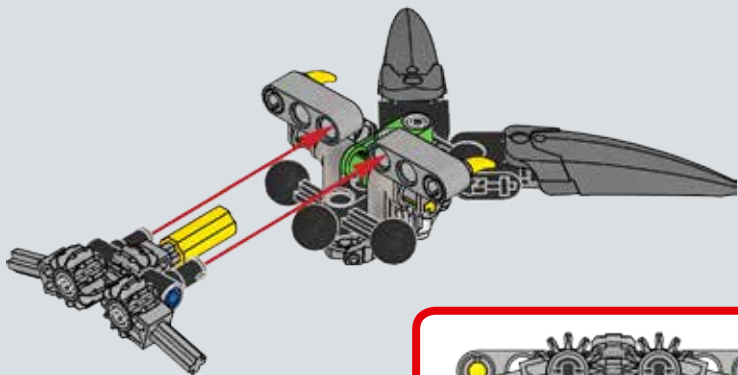

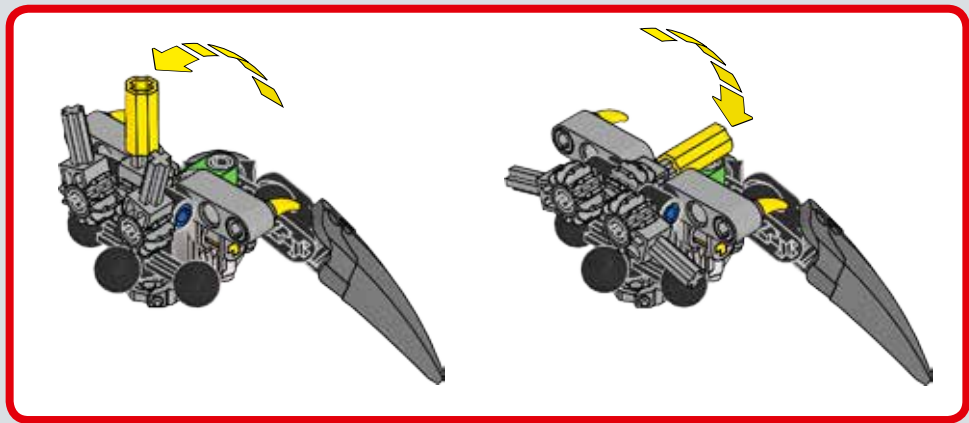

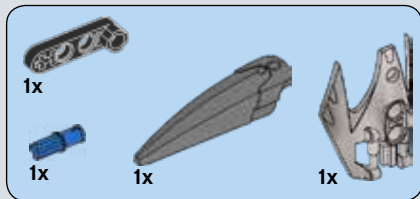

7

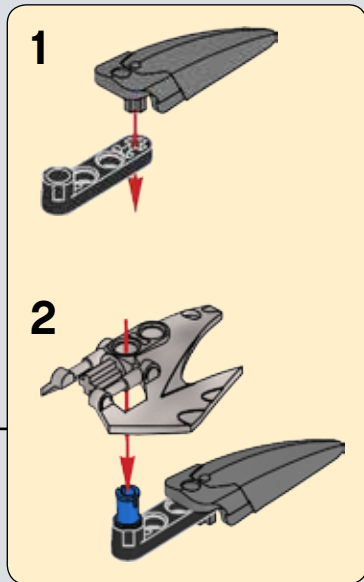
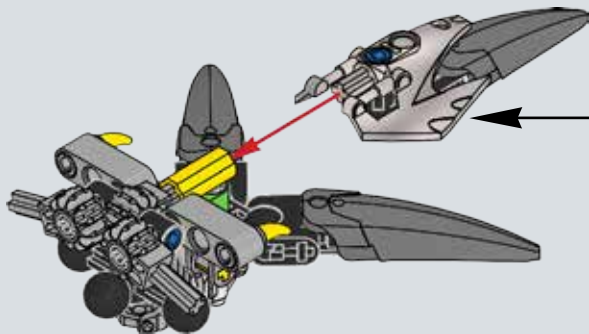

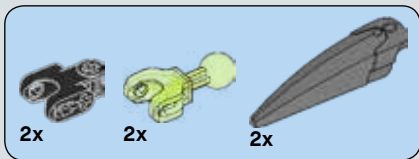

8

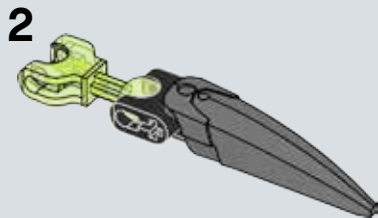
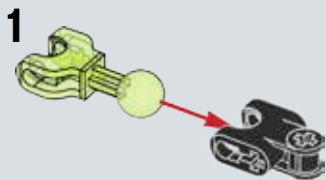

2x



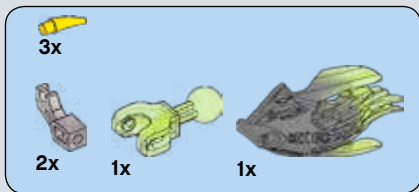

9

1

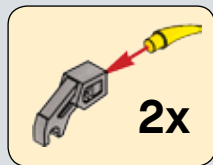
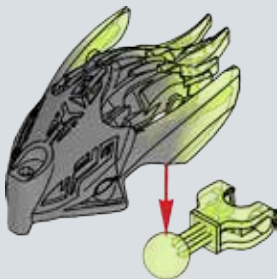

2

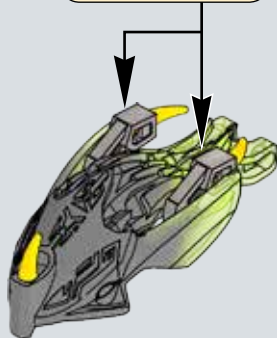

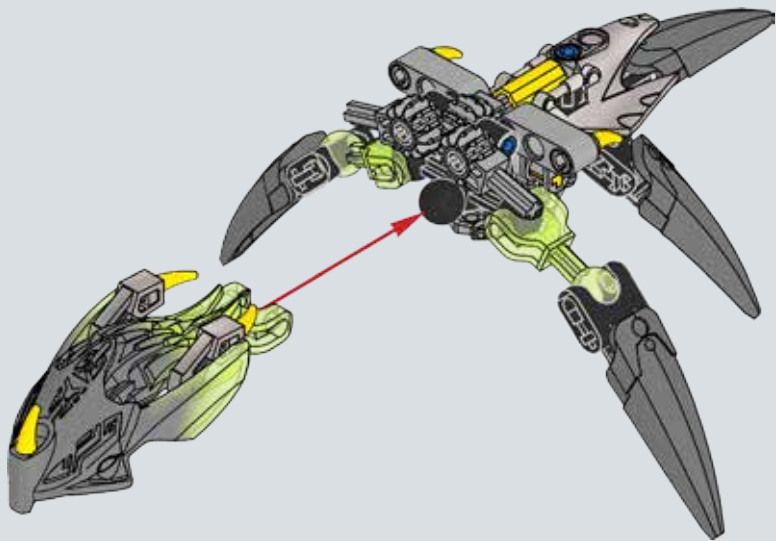

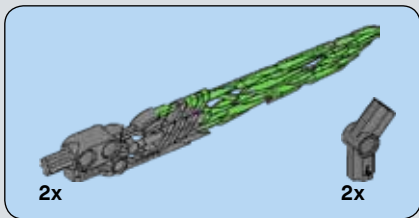

10

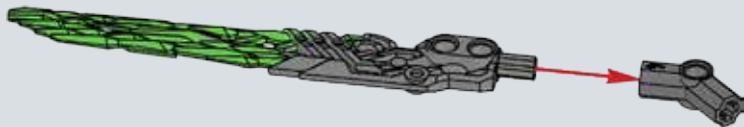

2x

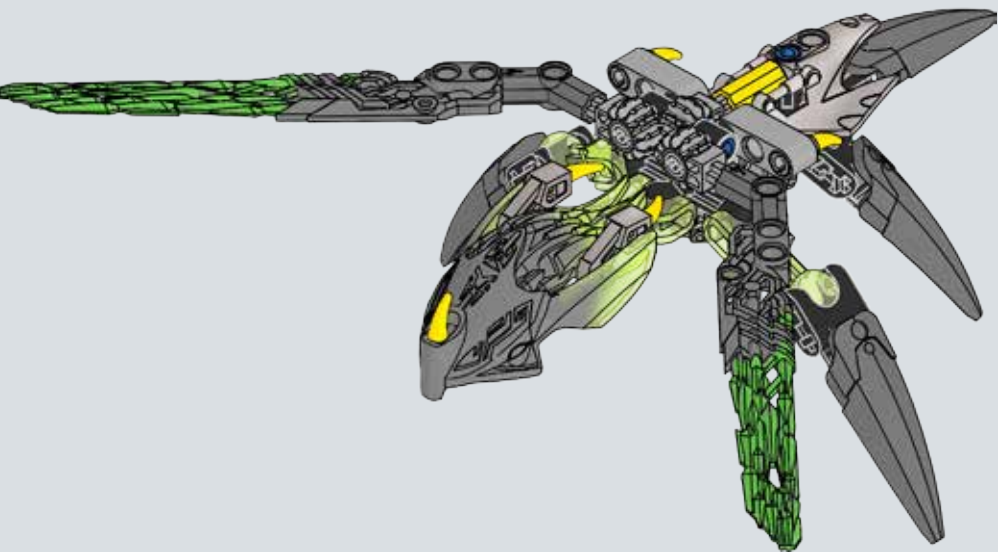

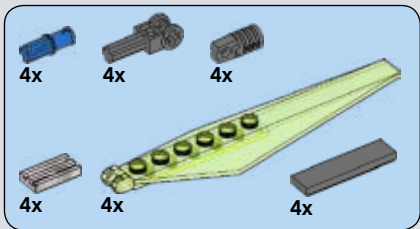

11

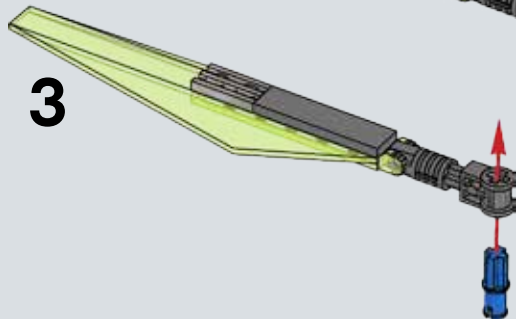
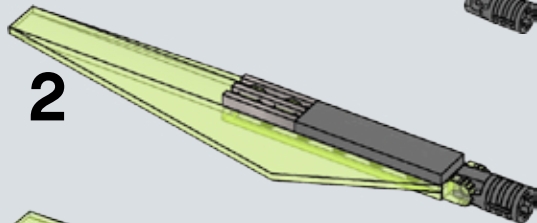
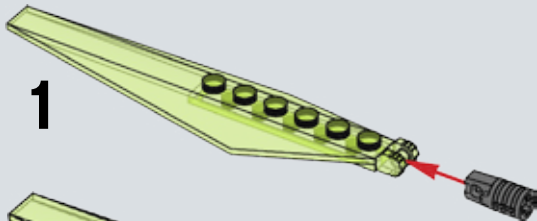

12

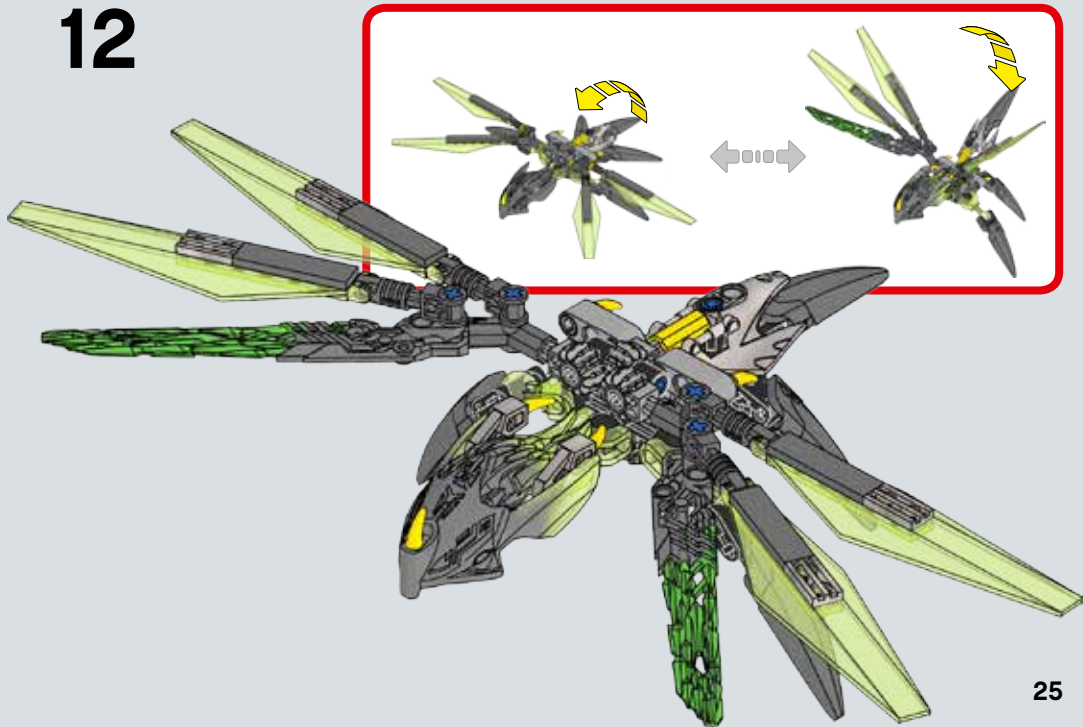

1x
6013938

5x
4206482

1x
4514553

1x
4519010

1x
6130008

5x
6014033

4x
4610948

1x
4107136

2x
4560174

2x
4121715

1x
4667277

1x
6097398

1x
4497943

4x
4655210

3x
4211483

3x
6134848

1x
4211679

2x
4538007

4x
4210694

2x
4210688

4x
4210665

4x
4211053

1x
4210695

5x
6133824

3x
6106244

1x
6135057

2x
6150661

4x
6133118

6x
6008483

6x
6124042

4x
4619636

1x
6016585

1x
6135237

2x
6135124



Customer Service

Kundenservice

Service Consommateurs

Servicio Al Consumidor

LEGO.com/service or dial



00800 5346 5555 :

1-800-422-5346 :





BIONICLE

71310



 LEGO.com/bionicle

Download App
Télécharger
l'application
Descarga la App



 Download on the
App Store

GET IT ON
 **Google play**

Apple, the Apple logo, iPad, iPhone and iPod touch are trademarks of Apple Inc.

Apple, le logo Apple, iPad, iPhone et iPod touch sont des marques de commerce d'Apple Inc.

Apple, el logotipo de Apple, iPad, iPhone e iPod touch son marcas comerciales de Apple Inc.

Google Play is a trademark of Google Inc.

Google Play est une marque de commerce de Google Inc.

Google Play es una marca comercial de Google Inc.



UNITE for battle



UNIS-LES pour le combat • Sólo podemos luchar UNIDOS



71300

71305



71303

71308



71301

71306



71304

71309



71302

71307



71311

71311



71311

71302

71301

71311

71307

71306



71303



71300



71304



71308



71305



71309